

Tabela orientativa de esquemas de ligações

Motores Monofásicos

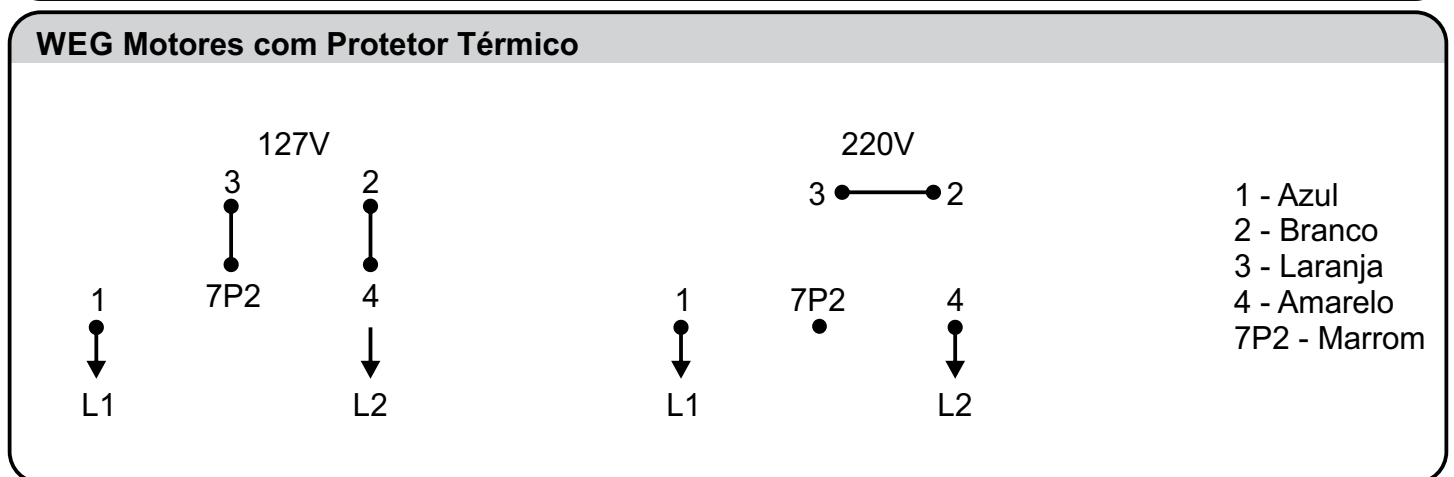
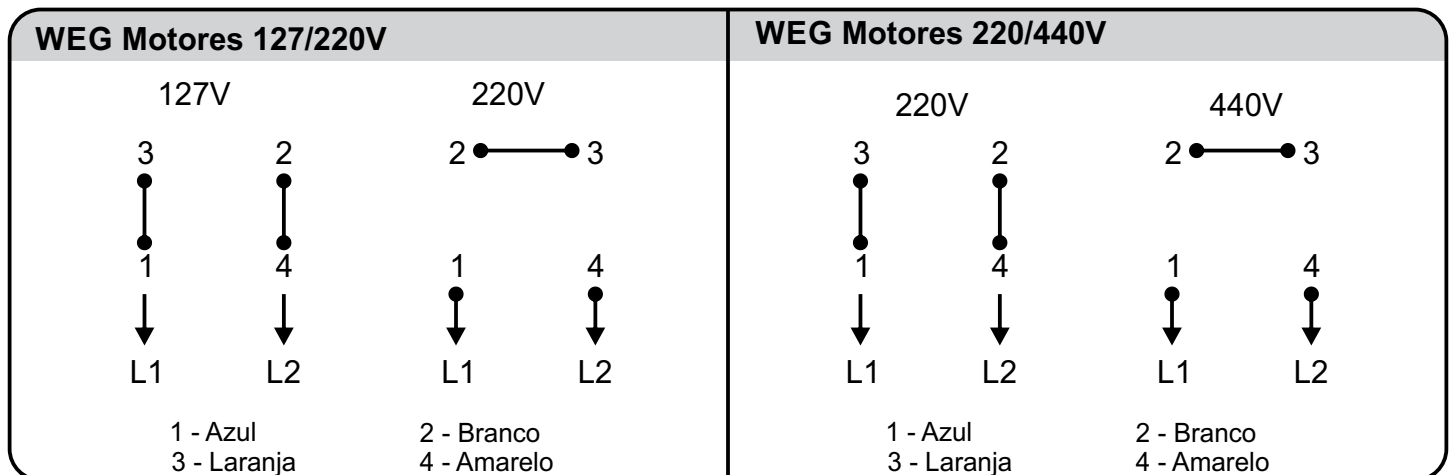
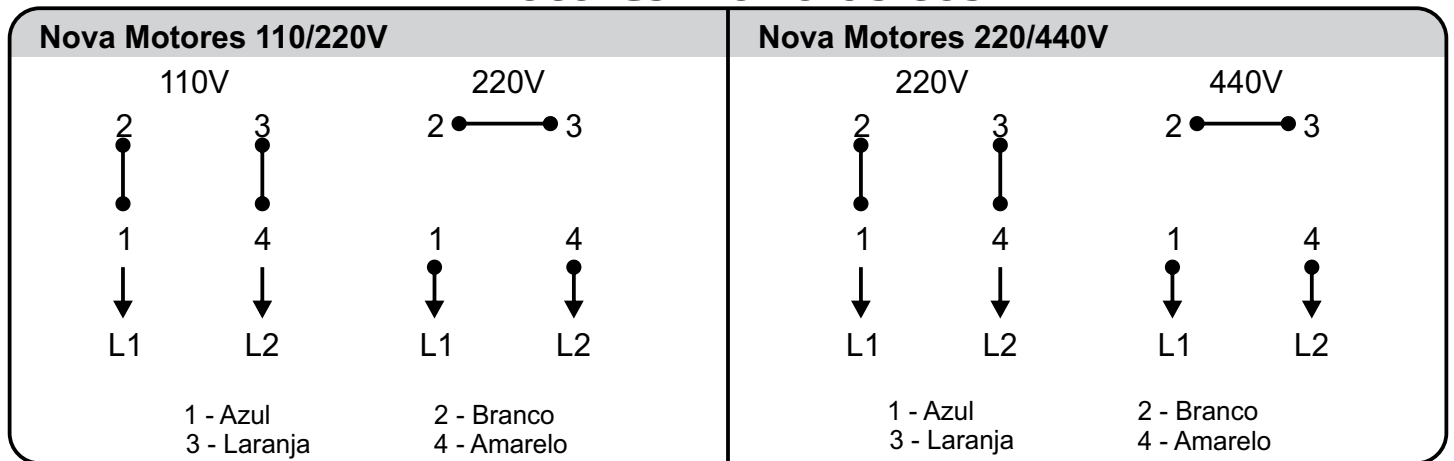

Tabelas orientativas. Em caso de dúvidas, consulte o fabricante.

Tabela orientativa de esquemas de ligações

Motores Monofásicos

XKm, XKSm

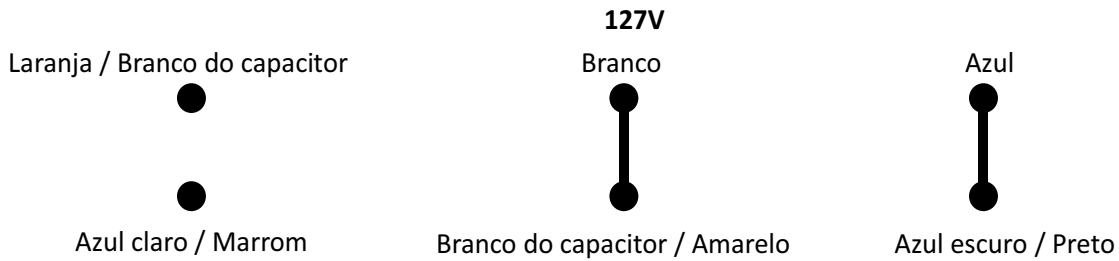

Obs. Os fios Azul escuro e Marrom podem estar invertidos na parte de baixo.

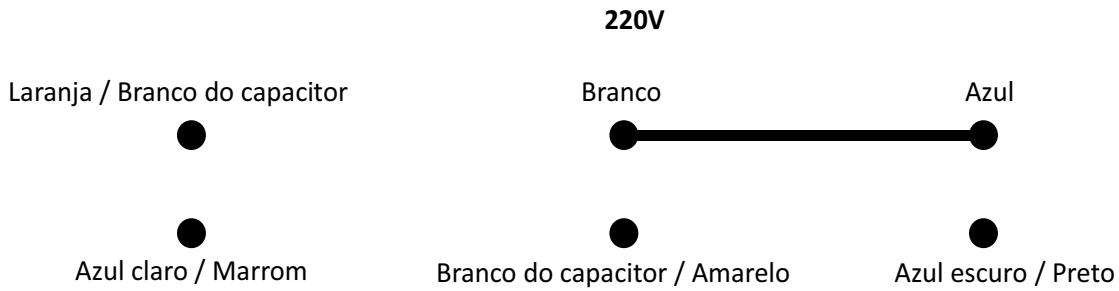

Obs. Os fios Azul escuro e Marrom podem estar invertidos na parte de baixo.

Vista: Olhando a bomba com o recalque e a sucção a esquerda, capacitor acima da ligação.

XCm, 2XCm, XHSm

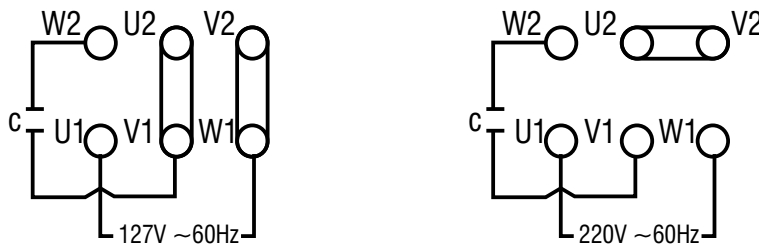

HSIS

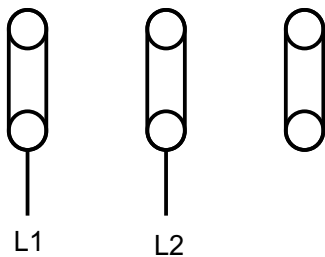

ESPA

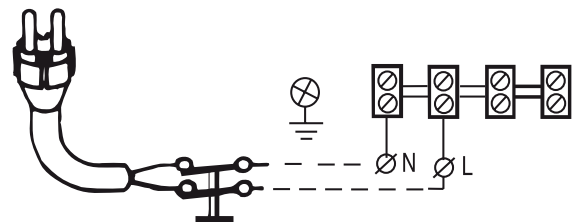

DAB - Jetcom

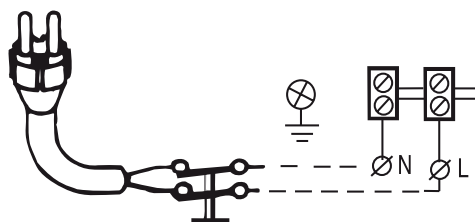

Tabelas orientativas. Em caso de dúvidas, consulte o fabricante.

Tabela orientativa de esquemas de ligações

Motores Trifásicos

XKT

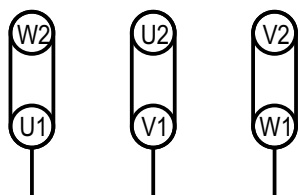

220V - 60Hz

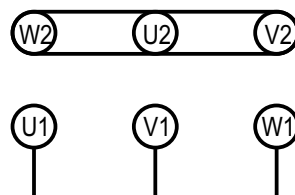

380/440V - 60Hz

12 cabos

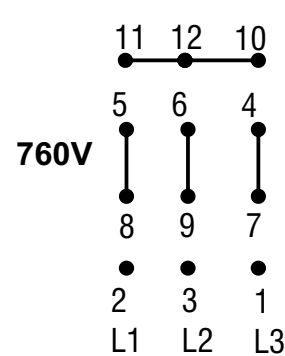
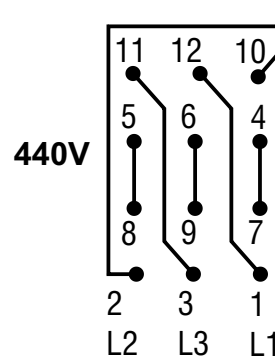
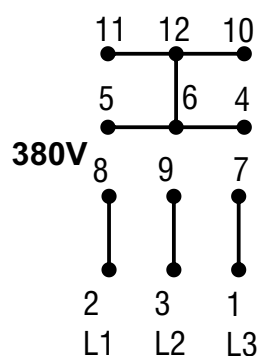
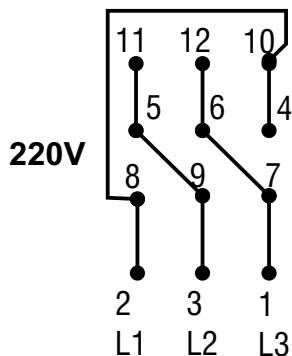

6 cabos

Motor
220/380V

220V

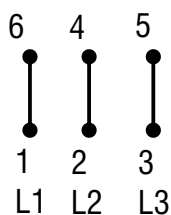

380V

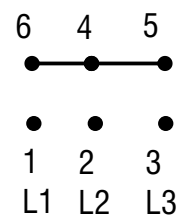

Motor
380/660V

380V

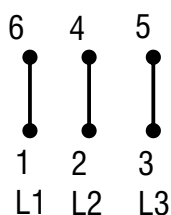

660V

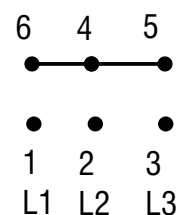

Motor
440/760V

440V

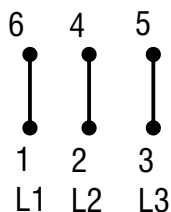

760V

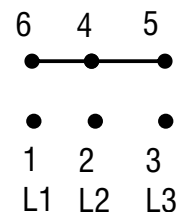

Tabelas orientativas. Em caso de dúvidas, consulte o fabricante.

Tabela orientativa de esquemas de ligações

Motores Trifásicos

HOMA 12 cabos

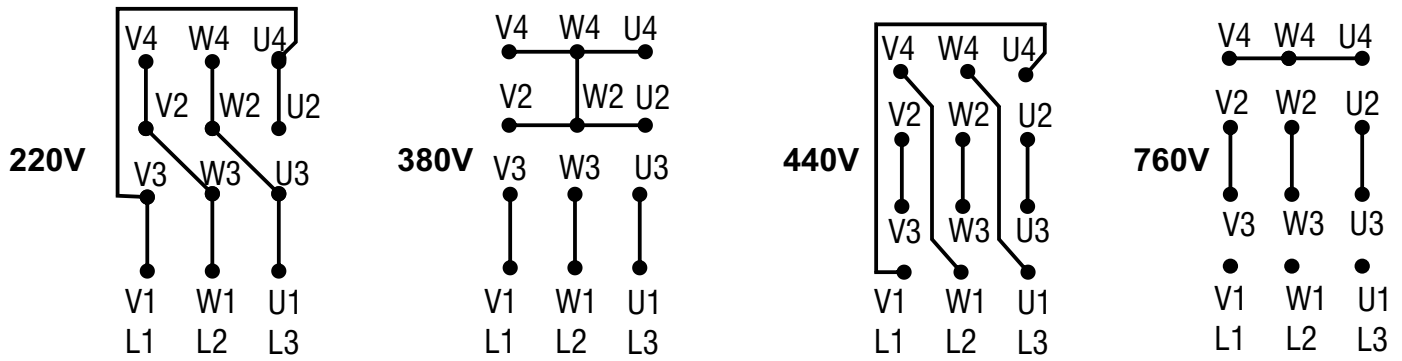

HOMA 6 cabos

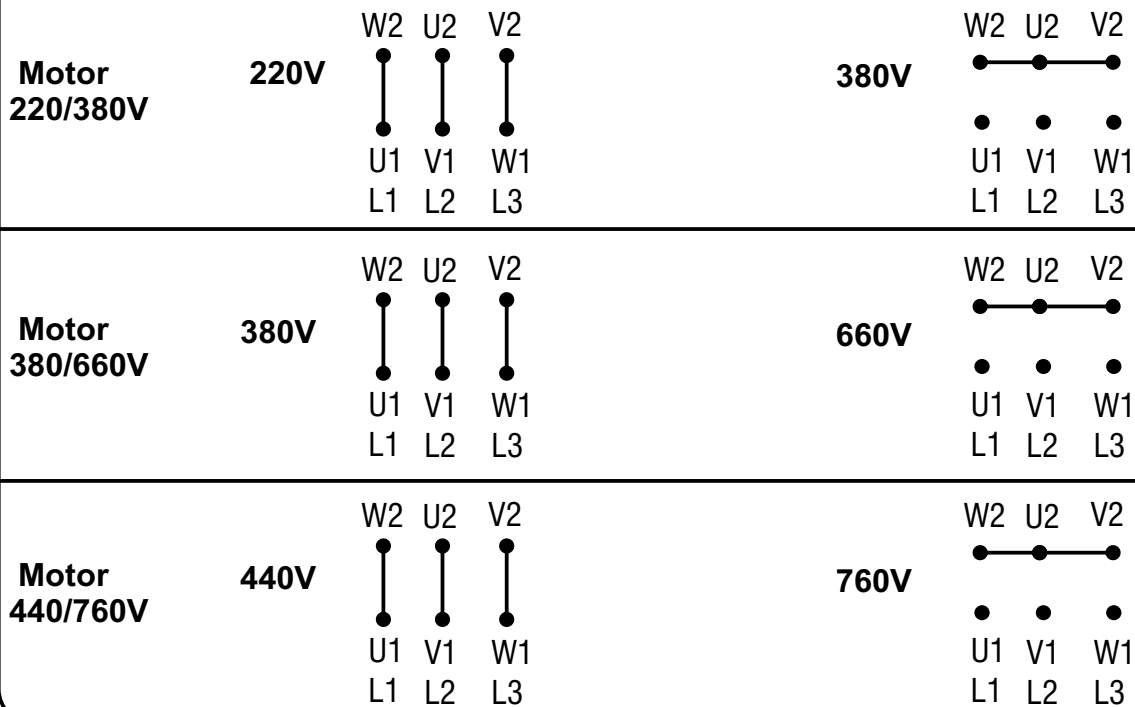

HCP

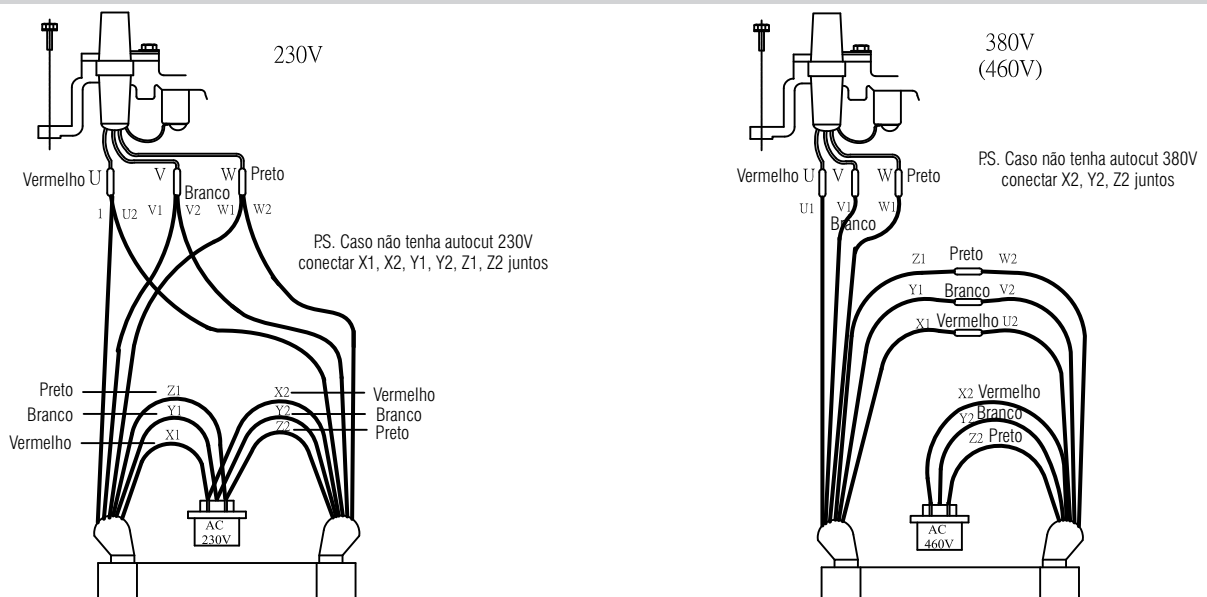

Tabelas orientativas. Em caso de dúvidas, consulte o fabricante.

Motores FBS-NG e FBS-JAC-NG

BOMBAS MONOFÁSICAS

127V

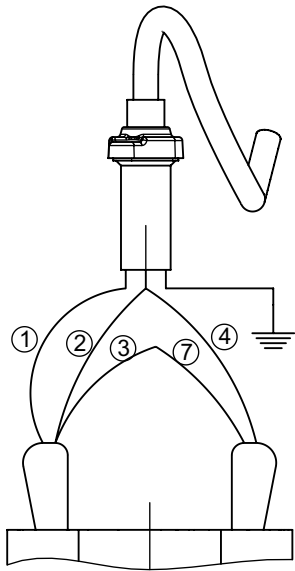

220V

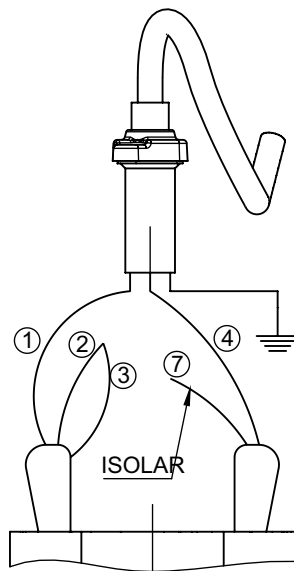

BOMBAS TRIFÁSICAS COM PROTETOR TÉRMICO

220V

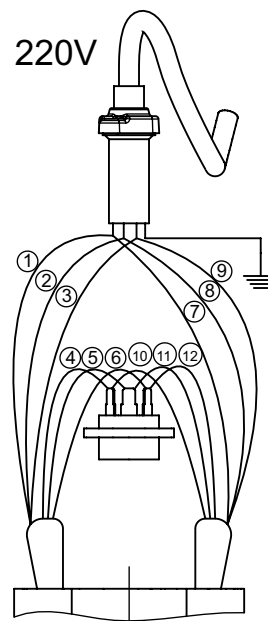

380V
440V

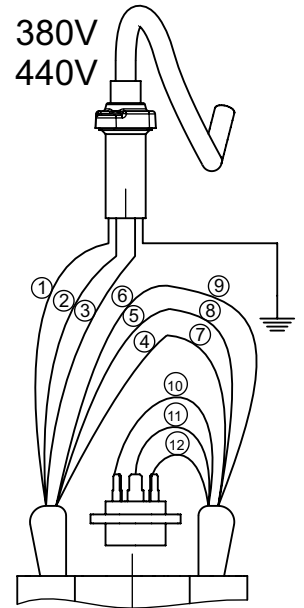

BOMBAS MONOFÁSICAS COM CHAVE BÓIA

127V

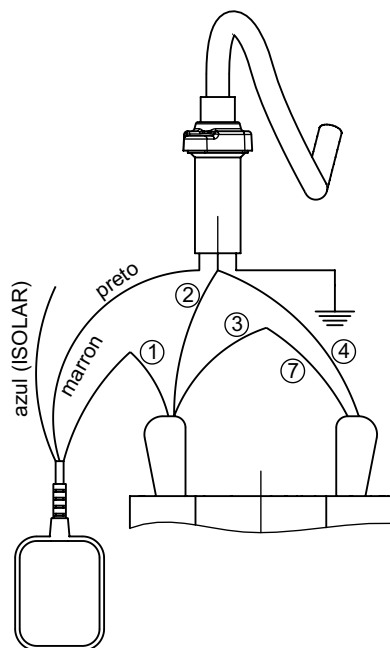

220V

